

Important Safety Instructions

When using your telephone equipment, basic safety precautions should always be followed to reduce the risk of fire, electric shock and injury, including the following:

1. Read and understand all instructions.
2. Follow all warnings and instructions marked on the product.
3. Unplug this product from the wall outlet before cleaning. Do not use liquid cleaners or aerosol cleaners. Use a damp cloth for cleaning.
4. Do not use this product near water (for example, near a bath tub, kitchen sink, or swimming pool).
5. Do not place this product on an unstable cart, stand, or table. The product may fall, causing serious damage to the product.
6. Slots and openings in the cabinet and the back or bottom are provided for ventilation. To protect it from overheating, these openings must not be blocked by placing the product on the bed, sofa, rug, or other similar surface. This product should never be placed near or over a radiator or heat register. This product should not be placed in a built-in installation where proper ventilation is not provided.
7. This product should be operated only from the type of power source indicated on the marking label. If you are not sure of the type of power supply to your home, consult your dealer or local power company.
8. Do not allow anything to rest on the power cord. Do not locate this product where the cord will be abused by persons walking on it.
9. Never push objects of any kind into this product through cabinet slots as they may touch dangerous voltage points or short out parts that could result in a risk of fire or electric shock. Never spill liquid of any kind on the product.
10. To reduce the risk of electric shock, do not disassemble this product. Opening or removing cabinet parts other than specified access doors may expose you to dangerous voltages or other risks. Incorrect reassembling can cause electric shock when the appliance is subsequently used.
11. Do not overload wall outlets and extension cords as this can result in the risk of fire or electric shock.

12. Unplug this product from the wall outlet and contact Vtech customer support under the following conditions:
 - A. When the power supply cord or plug is damaged or frayed.
 - B. If liquid has been spilled into the product.
 - C. If the product has been exposed to rain or water.
 - D. If the product does not operate normally by following the operating instructions. Adjust only those controls that are covered by the operating instructions, because improper adjustment of other controls may result in damage and will often require extensive work to restore the product to normal operation.
 - E. If the product has been dropped and the cabinet has been damaged.
 - F. If the product exhibits a distinct change in performance.
13. Avoid using a telephone (other than a cordless type) during an electrical storm. There may be a remote risk of electric shock from lightning.
14. Do not use the telephone to report a gas leak in the vicinity of the leak.



If you have questions about this product, or if you're having difficulty with setup or operation, do not return your phone to the store. Call our Customer Support Center at:

1-800-595-9511

In Canada, call 1-800-267-7377

Introduction

The **GIGAPHONE** is an advanced cordless telephone that operates in the 2.4GHz frequency range. Your **GIGAPHONE** is capable of supporting up to a maximum of 8 Handsets. Using additional Handsets, several people can be using the cordless system at the same time. Some examples:

- 2 Handsets conferenced on a **Line 1** call; while 2 additional Handsets are conferenced on a **Line 2** call.
- 2 Handsets conferenced on a **Line 1** call; while another Handset is in **Intercom** mode with the Base Unit.
- 1 Handset on **Line 1**; a different Handset in **Intercom** mode with the Base Unit; 2 additional Handsets are conferenced on **Line 2**.

This manual is designed to familiarize you with the **GIGAPHONE** cordless telephone. We strongly recommend you read the manual before using your phone.

To order additional system Handsets (model# VT20-2420), battery packs, or headsets, call VTech Communications Inc at 1-800-595-9511.

MENU DRIVEN DISPLAYS

The **VT20-2481** Handset and Base feature a user-friendly display, making it easy to access the many features of this multi-Handset, cordless system. The three black keys, found directly below the LCD screen, are called soft keys. They are called this because their functions change depending on what you're doing-making a call, reviewing Caller ID, adding a name and number to your Phone Book, etc.

For example, when the Handset is in the idle mode, the LCD display:



In this case, the 3 soft keys access **REDIAL**, **MENU** and **MEMORY**.

When the Handset is active, the LCD displays:



In this case, the 3 soft keys access **VOLUME**, **HOLD** and **MUTE**.

Parts Check List

1. Handset
2. Base Unit
3. Belt Clip
4. AC Power Adapter
5. Battery Pack
6. Telephone Cords(long x 2)
7. Owner's Manual

To purchase replacement battery packs, call VTech Communications Inc at 1-800-595-9511. In Canada, call VTech Electronics Ltd at 1-800-267-7377.



Handset

Base Unit

Belt Clip

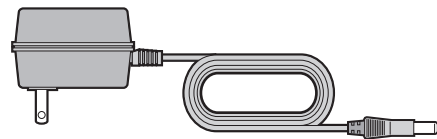

AC Power Adapter

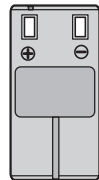

Battery Pack



Telephone Line Cord (Longx2)

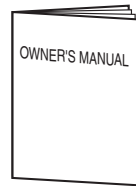

Owner's Manual

The Handset Layout

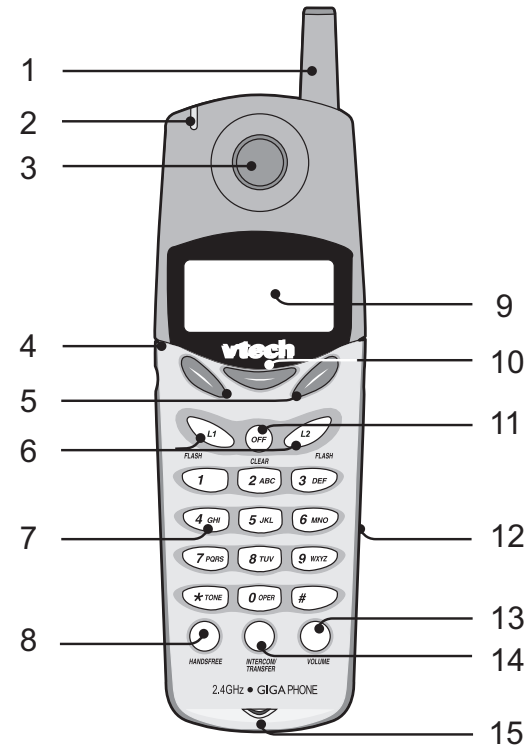

- | | |
|------------------------------|-------------------------------------------|
| 1. Antenna | 9. LCD Display |
| 2. New Messages Indicator | 10. Select/OK |
| 3. Earpiece | 11. Off (Clear) |
| 4. Headset Jack (2.5mm) | 12. Battery Compartment (back of Handset) |
| 5. Scroll Keys | 13. Volume |
| 6. Line 1 and Line 2 (Flash) | 14. Intercom/Transfer |
| 7. Dialing Keys (0-9, *, #) | 15. Microphone |
| 8. Handsfree Speakerphone | |

The Base Unit Layout

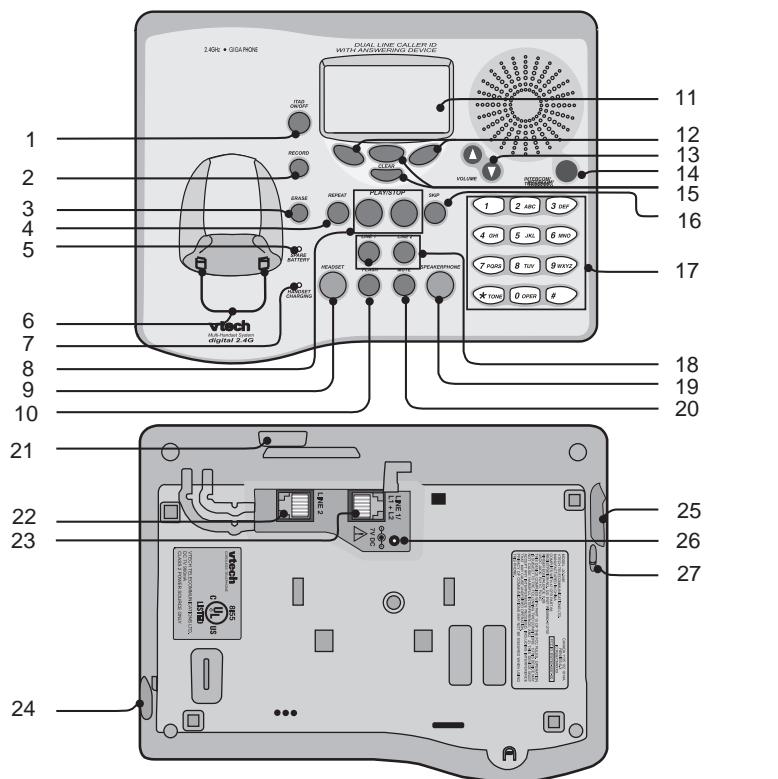

- | | |
|-------------------------------|---------------------------------|
| 1. Itad On/Off | 15. Select/Clear |
| 2. Record | 16. Skip |
| 3. Erase | 17. Dialing Keys (0-9, *, #) |
| 4. Repeat | 18. LINE 1/LINE 2 Keys |
| 5. Spare Battery Indicator | 19. Speakerphone Key |
| 6. Charging Contacts | 20. Mute |
| 7. Handset Charging Indicator | 21. Data Jack |
| 8. Mailboxes | 22. Line 2 Jack |
| 9. Headset Key | 23. LINE 1/LINE 1 + LINE 2 Jack |
| 10. Flash | 24. Headset Jack |
| 11. LCD Display | 25. Spare Battery Drawer |
| 12. Scroll Keys | 26. DC Connector |
| 13. Volume Keys | 27. Spare Battery Release |
| 14. Intercom | |

Setup

Plug the AC power adapter into an electrical outlet, and the DC connector into the back of the base unit.

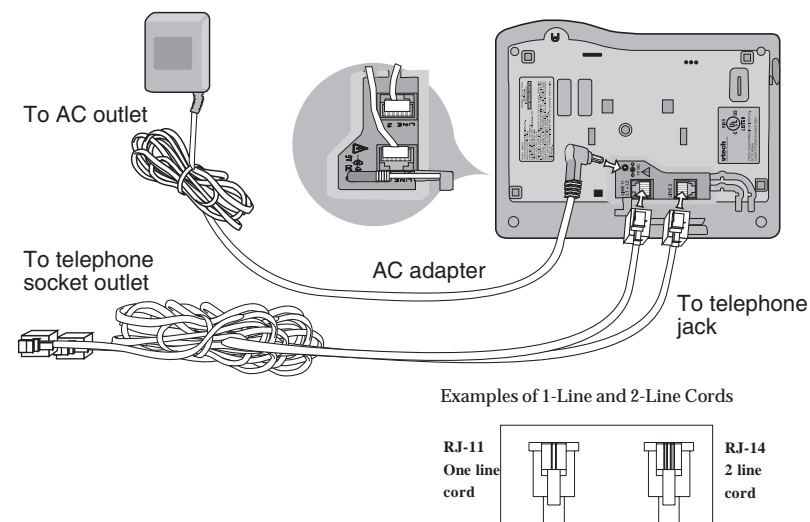

Connecting to the telephone lines

Your 2-Line **GIGAPHONE** will work fine even if you only have one telephone line. We recommend connecting the modular telephone cord to the jack labeled **LINE 1 / L1 + L2**, located on the bottom of the Base Unit. Here are steps for connecting **2** lines:

If you have **2 Lines** coming out of a **Single Wall Jack**:

Connect a **4-wire (RJ-14)** modular phone cord between the wall jack and the phone jack labeled **L1 / L1 + L2**.

If you have **2 Lines**, each coming out of **Separate Wall Jacks**:

Connect a modular phone cord from the wall jack you want to designate as your **LINE 1**, to the **LINE 1 / L1 + L2** jack on the bottom of the Base Unit. Next, connect a phone cord from the remaining wall jack to the **LINE 2** jack on the Base Unit.

Data Port

Your 2-Line **GIGAPHONE** has a Data Port on the back of the Base Unit. This port provides an easy way to connect your fax machine, laptop computer, modem or other telephone device for direct access to **LINE 2**.

The Data Port only provides access to Line 2, so you must have an active line connected to the **LINE 2** jack on the bottom of the Base Unit. Connect a modular phone cord from the Data Port (look for the small door marked **DATA** on the back of the Base Unit) to your fax, laptop, etc.

NOTE: While the Data Port is in use, accidental use of Line 2 by a parallel phone, your 20-2481, or a Call Waiting ID alert may interrupt the data transmission.

Installation of Battery Pack in Handset

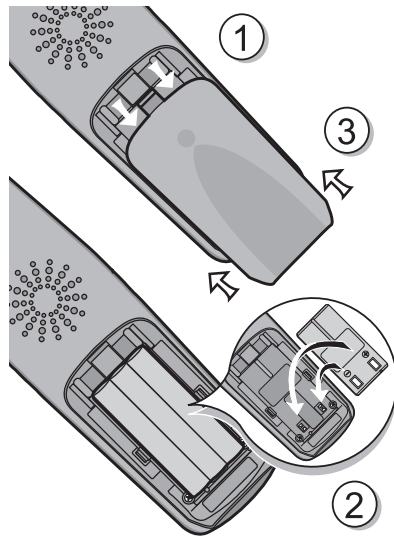

Follow the steps below:

1. Remove the battery cover by pressing on the indent and sliding downward.
2. Place the new battery pack in the handset with the metal contacts aligned with the charge contacts in the battery compartment.
3. Replace the battery cover by sliding it upwards.
4. If the new battery pack is not already charged, place the handset in the base unit, or a remote charging stand, and allow it to charge for 12 hours. After initial charge, a maintenance charge of 8 hours should be sufficient.

The original Handset that is shipped with your **GIGAPHONE** system will be automatically registered to the Base. This Handset is **HANDSET 1**.

As you register additional Handsets to the system, they will be assigned extension numbers in the following order: **HANDSET 2**, **HANDSET 3**, **HANDSET 4**, etc.

Whenever a charged Handset battery pack is installed, the Handset will automatically begin **SEARCHING FOR BASE** (if previously registered), or it will prompt you to **ENTER BASE ID** to register the new Handset. See **Registration and Operation** for details.

Charging Of Handset Battery Pack

Charging Of Handset Battery Pack

The Handset of your **GIGAPHONE** cordless telephone is powered by a rechargeable battery pack. It charges automatically whenever the Handset is in the Base Unit.

You should charge the battery pack for 12 hours when you first receive your phone. You'll know the battery pack needs charging when:

- The low battery message is displayed :
- The handset seems completely dead, the LCD is completely clear and does not activate when you press the keys.



IMPORTANT:

1. Do not dispose of a battery pack in a fire, the cell may explode.
2. Do not open or mutilate the battery pack. Toxic substances may be released, causing harm to eyes or skin.
3. Exercise care in handling battery packs in order to prevent an accidental short of the charge contacts, potentially causing the battery pack to overheat.
4. Do not dispose of this battery pack into household garbage. Contact your local recycling organization for recommended disposal sites.

Dial Tone

Checking for Dial Tone

After the battery is charged press a **LINE** Key on the Handset. **PHONE ON** will appear on the handset display, and you will hear dial tone. If not, see **In Case of Difficulty**.

Tone/Pulse Selection

Your GIGAPHONE is set for TONE dialing. See **Handset and Base Settings-SELECT TONE/PULSE AT THE BASE UNIT** for details.



CAUTION: Use only the Vtech power supply provided with your cordless phone.

IMPORTANT: FOR MAXIMUM PERFORMANCE OF YOUR CORDLESS TELEPHONE SYSTEM:

1. Choose a central location for your Base Unit.
2. Install your Base Unit and Extension Handsets away from electronic equipment, such as personal computers, television sets and microwave ovens.
3. In locations where there are multiple cordless telephones, separate base units as much as possible.
4. Install your telephone equipment away from heat sources and sunlight.
5. Avoid excessive moisture, dust or extreme cold.

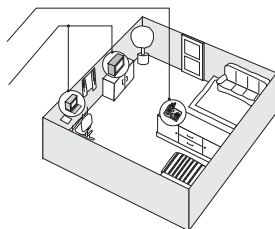

BEFORE USING YOUR HANDSET(S), CAREFULLY PEEL OFF THE PROTECTIVE FILM, COVERING THE DISPLAY.

Spare Battery Charger/Power Backup Function

The GIGAPHONE uses the spare battery charger in the Base Unit to provide operational backup in the event of a power failure. With the a fully charged battery pack in the spare battery charger, you will still be able to place and receive calls from the Handset for up to one hour. During Power Backup mode, you will not be able to use the Base Unit.

The spare battery pack can also be used to replace a drained handset battery, ensuring uninterrupted use.

NOTE :

When using the GIGAPHONE during Power Backup mode, audio quality may be compromised due to reduced power availability.

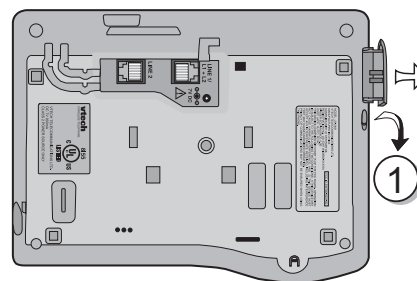

1. Open the spare battery charger by pressing the release button, located on the left-hand side of the Base Unit. A drawer will open to reveal the spare battery compartment.
2. Place a battery pack in the drawer with the charge contacts facing up and to the right.
3. Push the drawer closed.

The spare battery takes 24 hours to fully charge a drained battery.

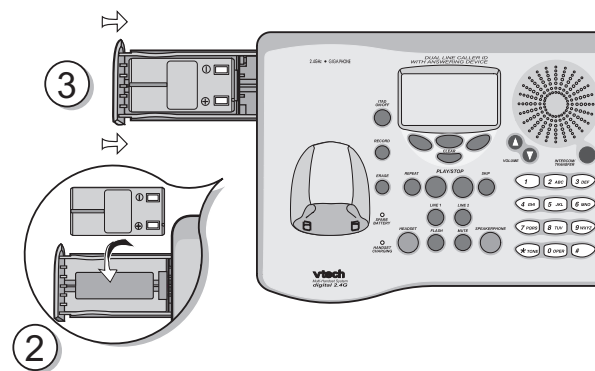

Registration and Operation

Registration And Operation Of The VTech VT20-2420 Accessory Handset

Your VTech GIGAPHONE system can operate up to **8 Handsets**.

The VTECH accessory Handset consists of the following:

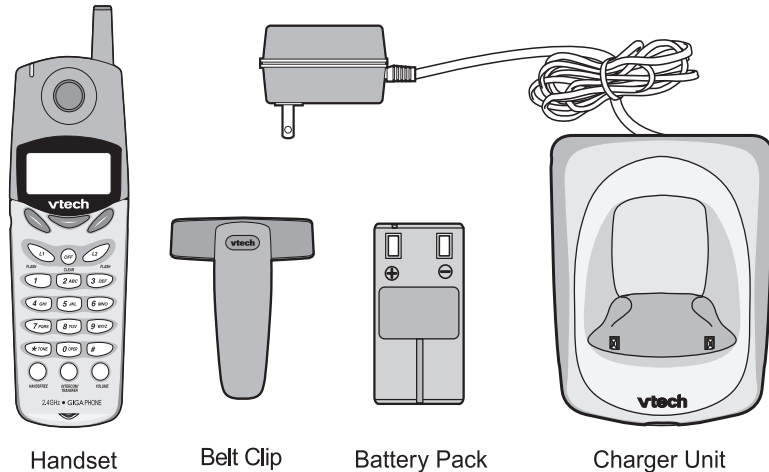

Handset

Belt Clip

Battery Pack

Charger Unit



Setup Of The VT20-2420 Accessory Handset

1. Plug the AC power adapter into an electrical outlet.
2. Remove the Handset battery cover by pressing on the indent and sliding downward.
3. Place the new battery pack in the Handset, with the metal contacts aligned with the charge contacts in the battery compartment.
4. Replace the battery cover by sliding it upward.
5. Place the Handset in the Charge Cradle, and allow it to charge for 12 hours. After the initial charge, a maintenance charge of 8 hours should be sufficient.

Registration and Operation

Enter Base ID Code

1. After charging the Handset, remove it from its Charge Cradle; the screen will display:

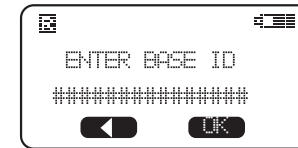

alternating with this screen:



2. If, after charging the Handset, you see:
3. Press **NEW**. You will now see the **ENTER BASE ID** screen as described in step 1.
4. Find the **BASE ID Code** by doing the following: (the Base must be in idle (OFF) mode)
 - A. At the **Base**, press **MENU**
 - B. Scroll down to **DISPLAY BASE-ID**
 - C. Press **OK**. The Base screen will display the 15-digit **ID Code**. Afterwards, it will return the idle screen.
5. Enter the 15-digit **Base ID Code** into the **Handset**; then press **OK**.



6. Wait approximately 15 to 60 seconds. You will hear confirmation beeps from the Base and Handset. The newly registered Handset will now assign itself the lowest handset number not previously assigned to a different system Handset (1 through 8).











7. If the Handset displays **REJECTED BY BASE** or continues to display **SEARCHING FOR BASE** for well beyond 60 seconds, try the registration process again by repeating the above steps.

Congratulations! You can now enjoy the benefits of your 2-Line VTECH Multi-Handset system.

Handset and Base Indicators

Handset and Base Icons

Icon	Description
	<u>Line In Use indicator</u> On steady with no number next to it when a parallel set is in use. On steady with one or more numbers next to it, indicating which extensions are using the line. For example,  02 indicates that Base (0) and Handset 2 are on a call on Line 1.
	<u>Intercom indicator</u> On steady with the extension numbers currently on an intercom call. For example,  02 indicates that the Base and Handset 2 are on an intercom call.
	<u>Mailboxes In Use Indicator</u> On steady when the mailboxes are in use. For example,  02 indicates that the Base mailboxes are in use.
	<u>Battery indicator (only in Handset)</u> Cycles (Low, Medium, and High) when Handset battery is charging. Flashes when a low battery condition is detected.
E	<u>Enhanced Mode indicator</u> On steady when active Handset or Base is in Enhanced mode.
M	<u>Mute indicator</u> On steady when the Handset or Base microphone is muted.
H	<u>Hold indicator</u> On steady when the line is on hold.
R	<u>Handset Registration indicator(only in Handset)</u>  is displayed when a Handset is either not registered, or is searching for a Base unit.

Handset and Base Indicators

Handset LEDs

LED	Description
NEW MESSAGES	<ul style="list-style-type: none"> Green light at the top of the Handset blinks to indicate that you have new messages in your Mailboxes.

Base LEDs

LED	Description
MAILBOX L1/ MAILBOX L2	<ul style="list-style-type: none"> Flashes to indicate that you have new messages. Glows steadily when there are previously played messages stored in the mailbox.
Line 1 Line 2	<ul style="list-style-type: none"> Lights when line is being used by the GIGAPHONE system. Flashes when another telephone on the same line (parallel extension) is in use. Flashes when a call is placed on HOLD.
Handset Charging	<ul style="list-style-type: none"> Lights whenever the Handset is placed in the Base Unit charging cradle.
Mute	<ul style="list-style-type: none"> Lights when Base microphone is muted.
Speakerphone	<ul style="list-style-type: none"> Lights when Base Speakerphone is in use.
Spare Battery	<ul style="list-style-type: none"> Lights when a spare battery pack is charging in the Base Unit charger.
Headset	<ul style="list-style-type: none"> Lights when the HEADSET option is in use on the Base Unit.

Soft Menu Functions

The GIGAPHONE has an advanced design that uses a menu structure and soft keys to access all of the built-in features.

Example of the idle mode display:



RDL (Redial)

Press **RDL** to display the last 5 telephone numbers dialed. The number on the top line is the most recent number dialed.

- Use the scroll keys to select the desired the number.
- To dial the number, you can simply press a **LINE** or the **HANDSFREE** key.
- You can erase a redial number by scrolling until it is highlighted, then press **SELECT**, and then **ERASE**.
- You can save a redial number to phone book memory by scrolling until it is highlighted, then press **SELECT**, and then press **SAVE**. Then add a **NAME** to your entry by following the instructions under **To Store a Number/Name**.

HANDSET MENU

With the Handset in the idle (OFF) mode, press the **MENU** key to access the following options:

- **CALL HISTORY (Caller ID)**
- **MAILBOXES**
- **HANDSET SETTINGS**
- **REGISTER**

Use the scroll keys to select the desired option, then press **OK**. Press the **OFF/CLEAR** key to step back through the menu structure. Press and hold the **OFF/CLEAR** key to return to the idle menu.

BASE UNIT MENU

With the Base Unit in the idle (OFF) mode, press the **MENU** key to access the following options:

- **CALL HISTORY (Caller ID)**
- **MAILBOXES**
- **SETUP BASE**
- **DISPLAY BASE-ID**

Press the **CLEAR** key to step back through the menu structure. Press and hold the **CLEAR** key to immediately return to the idle menu.

Call History (Caller ID)

Caller ID - Call Waiting ID

Your GIGAPHONE is capable of displaying the name and/or number of the party calling before you answer the phone (**Caller ID**). It is also capable of displaying Caller ID information in conjunction with a Call Waiting alert signal (**Call Waiting Caller ID**). With Call Waiting Caller ID, the Caller ID data is displayed so you can decide whether to answer the incoming call, or continue with your current conversation.

As new **Caller ID/Call Waiting ID** are received, your **Handset and Base displays** will alert to the new, **Caller ID records**, for example:



The number of new calls displayed on each system Handset and Base may not be the same. If, for example, you answer a call on **Handset 2**, that Handset will not count the Caller ID information for that call as *new*. However, the other registered Handsets and Base displays will consider it a *new call*, and add it to the **NEW CALLS** total.

After you review all new Caller ID records, the **NEW CALLS** status will be turned off.

The following information explains how to access Caller ID records(**Call History**):

From Handset or Base:

- From the idle (OFF) mode, press **MENU**. **CALL HISTORY** is highlighted. Press **OK**. The Caller ID information of the most recent inbound call will be displayed:
- For example: if the call was from Line 1:
- To view other Caller ID records, use the scroll keys. You can scroll from newest to oldest record by using the scroll key, or from oldest to newest by using the scroll key.
- To dial the displayed number, press the desired **LINE** key.
- If you need to dial the number differently than how it is displayed, press **MENU**. **DIAL OPTION *** is highlighted. Press **OK**.
- Scroll to the desired dialing option, then press **DIAL** or the desired **LINE** key to dial the phone number.



Call History (Caller ID)

DIAL OPTION SHORTCUT

With a Caller ID record displayed, press *. The 4 possible dialing options are displayed. Scroll to the desired dialing option, then press **DIAL**, or the desired **LINE** key to dial.

You can also **delete** and **save** Caller ID records in the Directory:

DELETE

With a Caller ID record displayed, press **MENU**.

Scroll to **DELETE CID 4**. Press **OK**.

The CID record is displayed, with the choices **THIS** (delete only this record) and **ALL** (delete all CID records).

If you press **THIS**, the displayed CID records will be deleted, and you will hear a confirmation beep.

If you press **ALL**, the screen will ask you **Are You Sure?** If you're sure, press **YES**, and all CID records will be deleted. If you decide not to delete all CID records, press **NO**.

DELETE SHORTCUT

With a Caller ID record displayed, press 4.

The CID record is displayed, with the choices **THIS** (delete only this record) and **ALL** (delete all CID records).

If you press **THIS**, the displayed CID records will be deleted, and you will hear a confirmation beep.

If you press **ALL**, the screen will ask you **Are You Sure?** If you're sure, press **YES**, and all CID records will be deleted. If you decide not to delete all CID records, press **NO**.



SAVE TO MEMORY

To save a displayed Caller ID record into the directory, press **MENU**.

Scroll to **SAVE TO MEM 7**. Press **OK**. -OR-

With the CID record displayed, press 7. The record has been stored in the directory.

If the record you wish to save does not have a name (OUT OF AREA, for example), the screen will ask you to **PLEASE ENTER A NEW NAME**. Use the keypad to enter the name, then press **SAVE**. A guide to the letters and characters can be found in the section entitled **Memory**.

Handset and Base Settings

NOTES ABOUT CALLER ID & CALL WAITING CALLER ID

These are subscription services, provided by most regional telephone service providers. You must subscribe to these services to get the benefits of these features. If you do not subscribe to Caller ID services, you can still use your GIGAPHONE and the other features it offers.

Due to regional incompatibilities, Caller ID information may not be available for every call you receive. In addition, the calling party may intentionally block their name and phone number from being sent.

• RINGERS

NOTE: The Handset and Base ringers are adjusted separately. In addition, each line is adjusted separately.

Handset:

Press **MENU**, scroll to **HANDSET SETTINGS**, then press **OK**.

RINGERS will be highlighted; press **SET**.



Highlight the desired adjustment, then press **SET**.



VOLUME : Use to sample the choices of loudness. There are five: OFF, LOW, MEDIUM, MEDIUM-HIGH and HIGH. Press **OK** to confirm your selection.



MELODY : Use to sample the six melodies. Press **SAVE** to confirm your selection.

Base Unit:



Press **MENU**, scroll to **SETUP BASE**, then press **OK**. Now follow the same procedure used for the Handset Ringers.

Handset and Base Settings



- **LOW BATT TONE**
Select this option to turn the Low Battery warning tone On or Off. Press the **OFF** or **ON** soft keys, to make your selection. Press **OK** to confirm your selection and return to the Handset Settings menu. When set to **ON**, the Handset will emit a warning tone when a Low Battery condition is detected. This feature has been preset at **ON** at the factory.
- **RANGE TONE**
Select this option to turn the Out of Range warning tone On or Off. Press the **OFF** or **ON** soft keys, to make your selection. Press **OK** to confirm your selection and return to the Handset Settings menu. When set to **ON**, the Handset will emit a warning tone whenever the Handset is taken out of range of the Base. This feature has been preset at **ON** at the factory.
- **KEYPAD TONE**
Select this option to turn the Keypad tones On or Off. Press the **OFF** or **ON** soft keys, to make your selection. Press **OK** to confirm your selection and return to the Handset Settings menu. When set to **ON**, the Handset will emit a beep whenever a key is pressed. This feature has been preset at **ON** at the factory.

Base Unit:

Press **MENU**, scroll to **SETUP BASE**, then press **OK**. Scroll to **KEYPAD TONE**; press **OK**. Choose **ON** or **OFF**, then press **OK** to confirm your choice.

- **CONTRAST**
Select this option to adjust the contrast level of the Handset display. Use the   scroll keys to make your selection. The handset display will automatically adjust as you make your selection. Press **OK** to confirm your selection and return to the Handset Settings menu.

Base Unit:

Press **MENU**, scroll to **SETUP BASE**, then press **OK**. Scroll to **CONTRAST**; press **OK**. Press  and  to adjust the screen contrast, then press **OK** to confirm your choice.

- **SELECT TONE / PULSE AT THE BASE UNIT**
With the Base Unit in the idle (OFF) mode, press **MENU**.
Scroll to **SETUP BASE**, then press **OK**.
Scroll to **SET PULSE/TONE**, then press **SET**.
Scroll to the desired **LINE**; press **SET**.
Use the **UP** and **DOWN** arrow keys to highlight the desired dialing mode - **TONE** or **PULSE**. Press **OK** to confirm your choice.

NOTE: Your **GIGAPHONE** is preset for **TONE** dialing, the desired mode for most areas.

Handset and Base Settings

- **ENHANCED MODE**
Your **GIGAPHONE** has an enhanced feature, designed to improve sound quality and range. If you are using your **GIGAPHONE** in an area with interference, the Enhanced Mode feature can help to improve both the sound quality and operating range. Actual range will depend on your environment. You can manually turn Enhanced Mode **ON** and **OFF**, or select **AUTO** mode.

To select the Enhanced Mode setting:

With the Handset in the idle (on hook) mode, press **MENU**.
Scroll to **HANDSET SETTINGS**, then press **OK**.
Scroll down to **ENHANCED MODE**, press **SET**.

Select **ON** to enable Enhanced Mode. When the Handset is in use, an 'E' icon will appear in the upper left corner of the display, indicating that this feature is active.

Select **OFF** to disable Enhanced Mode.

Select **AUTO** to allow your **GIGAPHONE** Handset to activate this feature automatically, when conditions warrant it. Your 2-Line **GIGAPHONE** is preset at the factory for **AUTO** mode.

Scroll to the desired setting, then press **OK**.

You can also activate Enhanced Mode from the Base Unit. In which case, all registered Handsets will have the same Enhanced Mode setting. With the Base in the idle (OFF) mode, press **MENU**, scroll down to **SETUP BASE**, press **OK**, scroll down to **ENHANCED MODE**, press **SET**, scroll to the desired setting, then press **OK** to confirm your choice.

NOTE: When Enhanced Mode is activated, your **GIGAPHONE** will consume more battery power. This means the standby and talk time of your Handset(s) will be shorter.

- **RENAME**
Naming your Handset(s)
You can personalize each Handset, giving it a name (Dad's Phone, or Mary's Office, for example) instead of **HANDSET 1**, etc.

With the Handset in the idle (on hook) mode:

Press **MENU**.

Scroll to **HANDSET SETTINGS**, then press **OK**.

Scroll to **RENAME**, then press **SET**.

Using the dialing keys, enter the desired name. A guide to the letters and characters can be found in the section entitled **Memory**. The  softkey will move the cursor to the right. Press **MORE** to give you the **DEL** (delete) and **SPACE** options. Press **BACK** to return to the previous screen.

Press **SAVE** to confirm your Handset name.



You can also name the Base Unit. At the Base, in the idle(OFF) mode, press **MENU**, scroll down to **SETUP BASE**, then press **OK**. Scroll down to **RENAME**, press **SET**, then follow the same steps as above for entering the desired name.

Register and Memory

Handset Deregistration

You can deregister all Handsets at one time. This causes the Base Unit to 'forget' that it has any Handsets at all. You may never have to perform this procedure. One possible reason for deregistration is if you have the maximum number of Handsets (8) registered to your Base, and one Handset should require replacement, the Base will not register the 'new' Handset, because its eight memory slots are occupied. The deregistration procedure will clear the Base Unit's memory, and you will be able to register each Handset again. Individual Handsets **cannot** be deregistered.

CAUTION: Once you deregister, your Handsets will not be capable of making or receiving calls. you will need to re-register each Handset, one at a time!!

To Deregister all Handsets:

- At the Base Unit, in the idle (OFF) mode, press **MENU**.
- Scroll down to **SETUP BASE**, then press **OK**.
- Scroll down to **DEREGISTER ALL**, then press **SET**.

All system Handsets have been deregistered. To register your Handsets again, see **Registration and Operation**, located in the **Getting Started** section of the User's Manual, for details.

Register

Use this option to register a Handset to the **GIGAPHONE** Base. You can register a total of eight Handsets to the **GIGAPHONE** Base. This process is activated automatically whenever a new handset is powered up in range of the **GIGAPHONE** Base.

You will be prompted to enter the 15-digit Base ID code. See **Registration and Operation**, located in the **Getting Started** section of the manual, for details.

Note : Base ID codes are 15 digits long and can include the following characters: 0, 1, 2, 3, 4, 5, 6, 7, 8, 9, *, , or # .

Memory

The Base and each Handset can store up to 50 names/numbers in memory. Each memory location can hold up to 32 digits and up to 16 characters for the name.

When prompted to **ENTER NAME**, use the digit keys to 'spell' the name. Each press of a particular key causes characters to be displayed in the following order:

Number Key	Characters (in order)
1	& ' , . 1
2	A B C 2 a b c 2
3	D E F 3 d e f 3
4	G H I 4 g h i 4
5	J K L 5 j k l 5
6	M N O 6 m n o 6
7	P Q R S 7 p q r s 7
8	T U V 8 t u v 8
9	W X Y Z 9 w x y z 9
0	0
*	*
#	#

Memory

To Store a Number/Name:

- Starting from the idle screen, enter the number you want to store in memory. If you make a mistake, press **CLEAR** to backspace.
- Be sure to include long distance codes and pauses, (using the **Pause** softkey) if necessary. Press the **MEM** softkey.
- You will then be prompted to **ENTER NAME**. Use the digit keys to 'spell' the name. If you make a mistake, press the **CLR** softkey. To enter a space press **⏏**. When finished, press **SAVE**.
- If there is space available in memory, the number/name will be saved and the Handset will return to idle mode.
- If the memory is full the Handset will display **PHONEBOOK IS FULL** and exit to the idle screen without saving the entry.
- Follow the above procedure for storing Number/Names at the Base. The Handset and Base have separate memories.

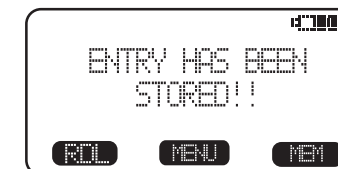
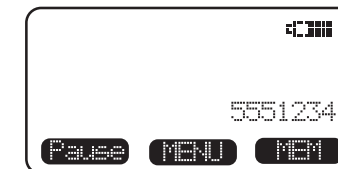
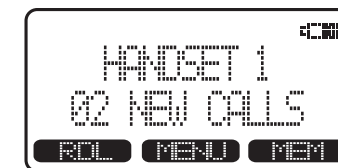

Memory

To Search For and Dial a Number/Name:

- Starting from the idle screen, press the **MEM** softkey to review memory contents.
- Using the **←** / **→** softkeys scroll through the memory contents in alphabetical order.
- Or, you can press the **FIND** softkey, enter the first few characters of the name and then press **FIND** to search. If you make a mistake, press **CLR** softkey. The closest match, in alphabetical order, will be displayed.
- Once you find the entry you want, simply press a **LINE** key or **HANDSFREE** to dial the number.

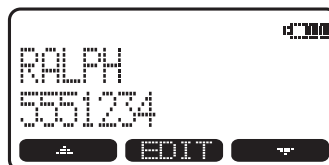
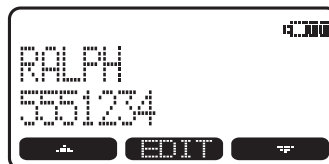
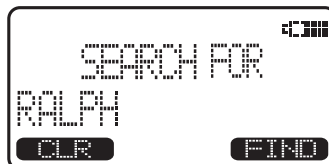
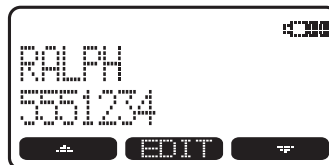
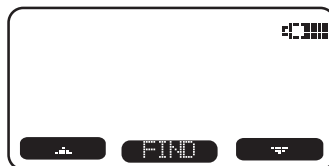

To Delete a Number/Name:

- Using the steps in **To Search For and Dial a Name/Number**, locate the entry you want to delete.
- Press the **EDIT** softkey. The Handset will display:

Memory

- Press the **DEL** softkey. The Handset will display:
- To delete this record, press **THIS**.
- To confirm the deletion of **ALL** records, press **YES**. To exit without deleting press **NO**.

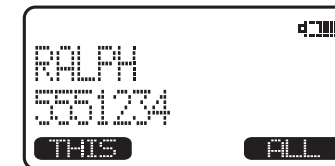

To Edit a Number/Name

- Using the steps in **To Search For and Dial a Number/Name**, locate the entry you want to edit.
- Press the **EDIT** softkey **twice**. The Handset will display:
- Select **NAME** or **NUM**. Using the **→** softkey move the cursor to the character you want to edit and then enter the corrections as needed. Press **MORE** to access **DEL**, **BACK** and **PAUSE/SPACE** functions. When finished press the **SAVE** softkey. To exit without saving press **OFF**.
- When finished the Handset will display the edited entry.

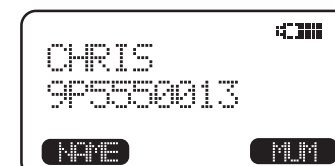
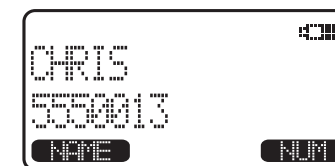
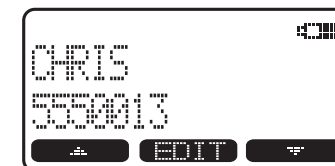

Handset and Base Operation

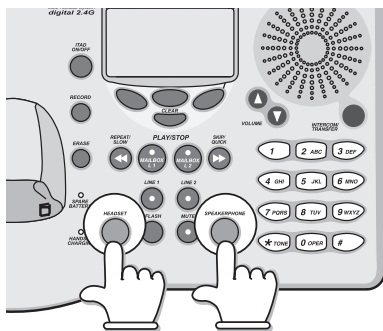
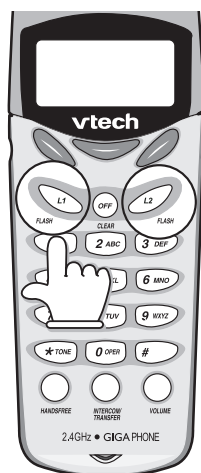

Making Calls

From the Handset

- Press a **LINE** key (or, **HANDSFREE** to use the Handset Speakerphone feature).

Dial the phone number.

-OR-

- Dial the phone number first; then press a **LINE** key (or **HANDSFREE**).

From the Base Unit

Just like the Handset, you can either access a dial tone first, then dial your number, or you can dial your number first, then access a line.

- With both lines idle, pressing **SPEAKERPHONE** (or **HEADSET** if you are using a headset connected to the Base) will access **LINE 1**.
- If you want to access **LINE 2** with both lines idle, press the **LINE 2** key first, then press **SPEAKERPHONE** (or **HEADSET**).
- If one line is **IN USE**, pressing **SPEAKERPHONE** (or **HEADSET**) will automatically access the idle line.
- If both lines are **IN USE** (2 or more system Handsets are active, with at least one on each line), pressing **SPEAKERPHONE** (or **HEADSET**) will access **LINE 1**.

NOTE: If **LINE 1** is in use, the phone will automatically select **LINE 2** when you press **HEADSET** or **SPEAKERPHONE** on the Base.

Handset and Base Operation

Redial

From either Handset or Base Unit

Each system Handset and Base Unit will remember the last 5 phone numbers dialed. From the *idle* mode, press **RDL**. Scroll until the desired phone number is highlighted. Then press the appropriate **LINE** key to dial the number (follow the above instructions in **Making Calls**).

You can also **delete** and **save** 'redial' numbers in the **Directory**.

ERASE

Press **RDL**. Scroll to the desired phone number, press **SELECT**, then press **ERASE**.

SAVE

Press **RDL**. Scroll to the desired phone number, press **SELECT**, then press **SAVE**.

You'll then be prompted to **ENTER NAME**. Use the keypad to enter the letters of the name. If you make a mistake, press **CLR** to backspace. To insert a space, press **SPACE**. When finished, press **SAVE**.

For more information on entering phone numbers into the Directory, see the section entitled **Memory**.

Answering Calls

From the Handset

Press the appropriate **LINE** key, or **HANDSFREE** to use the Handset Speakerphone option.

If the Handset is active on one line when the idle line rings, you will hear a special alert tone, signifying an inbound call. This alert is designed to minimize disruption of the call in progress. You can then:

- Press **OFF** twice to end the first call, then answer the new call;
- or -
- Press the appropriate **LINE** key to answer the new call. The original call will automatically be placed on **HOLD**. You can end the 'new' call by pressing **OFF**, then return to the original call by pressing the appropriate **LINE** key.

You can also Conference both lines together. See **Conference Calling**, further on in this User's Manual.

From the Base Unit

If a line is ringing, pressing **SPEAKERPHONE** (or **HEADSET** if you are using a Headset connected to the Base) will answer the inbound call.

Press **SPEAKERPHONE** (or **HEADSET**) to end your call.

Handset and Base Operation

If the Base is active on one line when the idle line rings, you will hear a special alert tone, signifying an inbound call. This alert is designed to minimize disruption of the call in progress. You can then:

- Press **SPEAKERPHONE** (or **HEADSET** if you are using a Headset connected to the Base) to end the first call, then answer the new call; - or -
- Press the **HOLD** soft key to place the original call on hold. After that, press the appropriate **LINE** key and then **SPEAKERPHONE** (or **HEADSET**) to answer the new call. You can end the "new" call by pressing **SPEAKERPHONE** (or **HEADSET**). Return to the original call by pressing the appropriate **LINE** key and then **SPEAKERPHONE** (or **HEADSET**).

You can also Conference both lines together. See **Conference Calling**, further on in this User's Manual.

Mute Function



During an active call pressing either the **MUTE** soft key on the Handset or the **MUTE** key on the Base (when in Speakerphone or Headset mode), will disable the microphone. Press **MUTE** key again to return to normal 2-way conversation.

Hold Function

From the Handset :

- Press the **HOLD** soft key to place a call on hold. To return to the call press the **LINE** key.

From the Base :

- During an active call, press the **HOLD** soft key to place a call on hold. The **LINE** key will flash to indicate a call is on hold.
- To return to the call press the appropriate **LINE** and then press **SPEAKERPHONE**. (or **HEADSET**)

You can use your **GIGAPHONE** with services such as call waiting. Simply press the **LINE** key on the Handset or the **FLASH** key on the Base (when in Speakerphone or Headset mode) to flash the line.

Flash Function

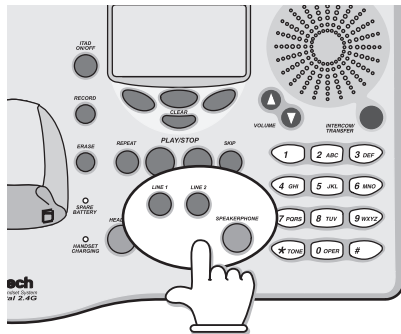

Handset and Base Operation

How to adjust the Handset Volume (also applies to the Handset Speakerphone)

NOTE: The Handset must be IN USE to adjust the volume

There are 2 ways to adjust Handset volume

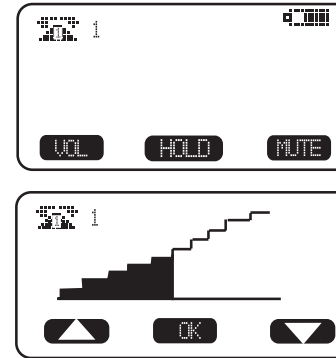

- Press the **VOLUME** key, located directly below the lower left corner of the display.
- Use the keys directly below the **▲/▼** symbols on the display or the **VOLUME** key to raise or lower the Handset volume. Notice the change in the display graph as you adjust the volume. An increase in volume will be represented by an increase in shaded area on the graph. A decrease in volume will result in a reduction of the shaded area.
- Press the **OK** key (top, center) to confirm your adjustment.

-OR-

Press the **VOLUME** key, located on the lower right edge of the Handset.

Repeated pressing of the **VOLUME** key will cycle through the 5 volume levels.

A rapid succession of beeps indicates you have reached the maximum or minimum volume setting.

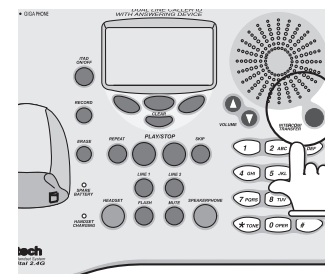
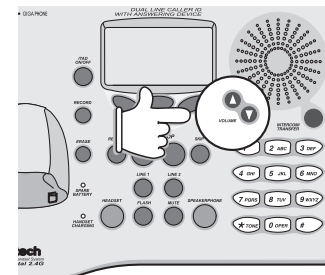

Base Speakerphone or Headset Volume

- During an active call simply press the Volume **UP** or **DOWN** keys to adjust the Speakerphone or Headset volume.

Intercom Function

Press **INTERCOM/TRANSFER** on any Handset registered to your 2-Line **GIGAPHONE** system, or the Base Unit.

The screen will display your options, for example:

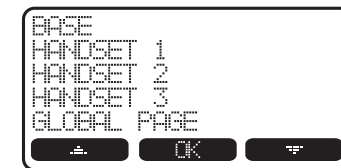

Handset and Base Operation

Highlight the desired destination of your **intercom** then press **OK**. Your screen will display **CALLING HANDSET __**, **CALLING BASE**, or **PERFORMING GLOBAL PAGE**.

The recipient's screen will display **INTERCOM FROM HANDSET 1**, or **GLOBAL CALL FROM HANDSET 1**.

The recipient presses **INTERCOM/TRANSFER** to engage in conversation with the person initiating the page.

NOTE: When you initiate a **GLOBAL PAGE**, the first recipient to respond by pressing **INTERCOM/TRANSFER** will be able to talk to you via the intercom. Others can join the ongoing intercom call by calling one of the parties involved in the intercom. The unit beeps whenever a party joins an ongoing call.

Transferring Calls

You can transfer calls on the **GIGAPHONE** system from the Base to Handset, Handset to Handset, or Handset to Base.

Blind Transfer

You can directly transfer any active call to another **GIGAPHONE** extension without notification by doing the following steps:

- Handset or Base must be on an active call.
- Press the **INTERCOM/TRANSFER**; scroll to the desired destination of your transfer. Then press **OK**.
- When the other extension answers, the call will automatically be connected to that extension.
- An unanswered call will ring back to the originating Handset/Base if not answered within 30 seconds.

Announced Transfer:

You can perform an announced transfer (call and advise another extension) of an active call by doing the following steps:

- Handset or Base must be on an active call.
- Place the active call on **HOLD**.
- Press the **INTERCOM/TRANSFER**; scroll to the desired destination of your transfer. Then press **OK**.
- When the other extension answers the intercom call, explain they have an active call waiting.
- Both extensions press **OFF** to end the intercom call.
- The other extension presses the **LINE** key, **HANDSFREE**, **SPEAKERPHONE** (or **HEADSET**) to pick up the call on hold.

Handsfree Speakerphone Operation

Your **GIGAPHONE** Handset has a built-in handsfree Speakerphone. This feature allows you to stand the Handset upright on a table or desktop and have handsfree conversations. For more information, refer to **MAKING CALLS in HANDSET AND BASE OPERATION**.

Handset and Base Operation

Switching from the Handset Earpiece to Handsfree

While on a call using the Handset earpiece, press **HANDSFREE** on the lower left portion of the Handset.

To return to the Handset earpiece, press **HANDSFREE** again.

Base Speakerphone Operation

The Base of your **GIGAPHONE** is equipped with a full duplex Speakerphone. This is a very useful feature for handsfree conversations or conference calls at the base unit. For more information, refer to **MAKING CALLS in HANDSET AND BASE OPERATION**.

Line in Use Indication

Active (off-hook) Handsets:

During a call, the Handset/Base screen will display, in the upper left corner, the **LINE** icon(s) and the **HANDSET/BASE** number(s) (1 - 8; 0 for the Base) currently in use.



Idle (on-hook) Base Unit:

During a call, the idle Base screen will display, in the upper left corner, the **LINE** icon(s) and the **HANDSET** number(s) currently in use.

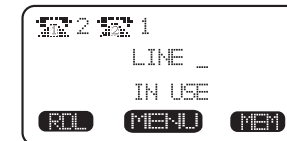

Idle (on-hook) Handsets:

During a call, the idle Handset(s) will display:

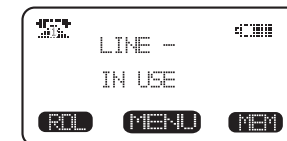

When one or both lines are currently in use by a parallel set (a telephone device other than your **GIGAPHONE** system), all registered Handsets and Base will display:



When both lines are in use at the same time, the **L_EXTENSION IN USE** message will alternate between **1** and **2**.

Low Battery Indication

When a low battery is detected, the Battery icon will flash and a warning beep is played. The status message **LOW BATTERY** will also be displayed when the Handset is in idle mode. To prevent an unexpected call drop, a drained Handset battery should be replaced by a fully charged spare battery.

Handset and Base Operation



Conference Calling

The **GIGAPHONE** is capable of supporting conference calls with up to **two** registered Handsets on each line, and the Base unit.

To enter a conference call, simply access the line with two or more extensions by pressing a **LINE key** (or **HANDSFREE**) on the Handset, or a **LINE key**, then **SPEAKERPHONE** (or **HEADSET**) on the Base.

The phone icon  and extension numbers of all local participants will be displayed in the upper left corner of the Handset.

2-LINE Conference Calls (Handset or Base)

- Make or answer a call on **LINE 1** or **LINE 2**. Place the call on **Hold**.
- Make or answer a call on the other line. Press **CONF**. You and your parties on **Lines 1** and **2** are now on a 3-way call.
- Press **LINE 1** or **LINE 2** on any other system Handset to join the Conference call.
- Press **SPEAKERPHONE** (or **HEADSET**) on the Base to join the Conference call.
- To drop a **LINE** from the Conference call, press **DROP**. Your screen will display **DROP LINE 1**, **DROP LINE 2** or **DROP BOTH LINES**. Using the  /  softkeys scroll to the desired option. Then press **OK**.

Answering System Operation

Your **VT20-2481** Answering System can be accessed for programming and listening to messages from either the Base or Handset. In addition, you can perform functions such as listening to messages and changing your outgoing greetings remotely from any touch-tone phone.

Messages from people calling on **Line 1** are stored in **MAILBOX 1**.
Messages from people calling on **Line 2** are stored in **MAILBOX 2**.

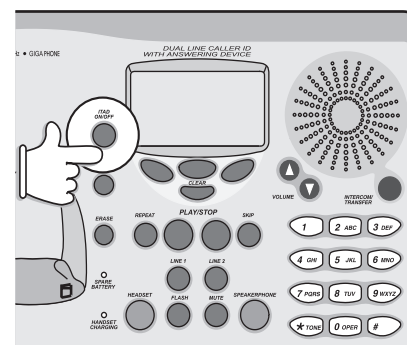

Turning Your Answering System ON/OFF From the Base Unit:

- Press the **ITAD ON/OFF** key. The Base will display :

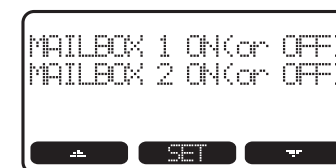

- Use the arrow keys to highlight the desired line, then press **SET** to change the current setting.
- Press **ON** or **OFF**, then press **OK** to confirm your choice.

NOTE: Your **20-2481** Answering System is programmed at the factory with both mailboxes turned ON.

If both Mailboxes are ON (ready to record messages for you on both **Line 1** and **Line 2**, the **ITAD ON/OFF** key will glow red.

If both Mailboxes are OFF (the Answering System will not take messages on either line), the **ITAD ON/OFF** light will go out.

If one Mailbox is turned ON and the other turned OFF, the **ITAD ON/OFF** light will blink.

Answering System Operation

ANSWERING SYSTEM SETUP (From either 20-2481 Handset or Base)

HELPFUL HINT: Press **CLEAR** anytime to back out of setup mode. Depending on where you are in the setup process, you may have to press **CLEAR** more than once to return to the idle screen.

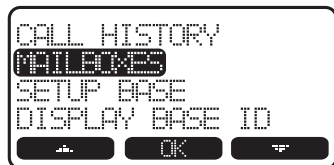

- From the idle mode, press **MENU**.
- Scroll to **MAILBOXES**, then press **OK**.



- Scroll to *either* **MAILBOX SETUP** line, then press **OK**.

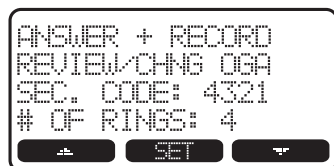

- You will now see the setting menu with the current selection for each setting.



- Scroll down to see additional settings with the current selection for each setting.

Answering System Operation

ANSWER + RECORD

Your **VT20-2481** Answering System is set at the factory to record messages from your callers (**ANSWER + RECORD** mode). However, if you do not want callers to leave messages (for example: after business hours), you can program one or both Mailboxes to play your outgoing greeting and then hang up. This is known as **ANSWER ONLY** mode.

NOTE: For each Mailbox, you can record an **ANSWER + RECORD** and **ANSWER ONLY** outgoing greeting. Your **VT20-2481** Answering System will remember all **4** greetings - 2 for each Mailbox!

If you do not record personal greetings, your **VT20-2481** will play its own outgoing greetings. We recommend you record your own greetings, with a recognizable voice and customized announcement.

Setting the Answer mode



- From the idle mode, press **MENU**.

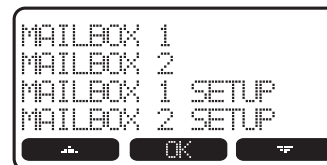

- Scroll to **MAILBOXES**, then press **OK**.

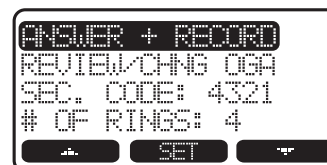

- Scroll to *either* **MAILBOX SETUP** line, then press **OK**.

- With **ANSWER + RECORD** highlighted, press **SET**.



- Scroll to **ANSWER + RECORD** (normal mode), or **ANSWER ONLY**.
- Press **OK**.

Answering System Operation

SECURITY CODE

To access your Answering System from a remote location, you will need to enter a 4-digit security code while the system is playing the outgoing greeting. Factory preset to **4321**, you can choose any 4-digit number, providing it does **not** begin with 1 or 2.

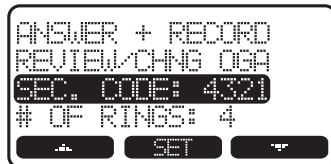
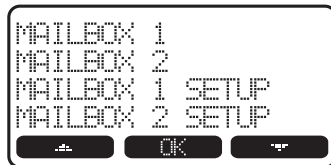
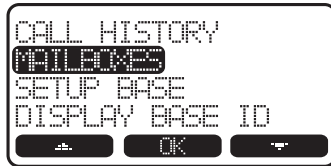

From the Handset or Base Unit:

- From the idle mode, press MENU.
- Scroll to MAILBOXES, then press OK.
- Scroll to *either* MAILBOX SETUP line, then press OK.
- Scroll to SEC. CODE: 4321 (showing the current setting). Press SET.
- Use the dial pad to enter a 4-digit number, then press SAVE.

You may want to write your security code down and keep it in a convenient place, in the event you forget the number!

Answering System Operation

NUMBER OF RINGS

Program each line separately to answer calls at a predetermined number of rings. Your options are 2, 4, 6 rings, or Toll Saver. Toll Saver will instruct the Mailbox to answer an incoming call after 2 rings if the Mailbox contains new, unplayed messages. If there aren't any unplayed messages, Toll Saver instructs the Mailbox to answer after 4 rings. Use Toll Saver if you're going out of town. When you access the Answering System remotely to check messages, if it doesn't answer after 2 rings, hang up. You don't have any new messages and you won't have to waste money on a long distance call.

From the Handset or Base Unit:

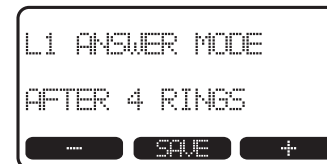
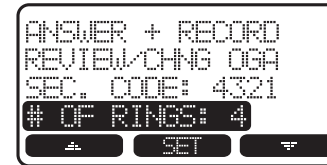
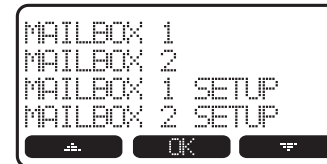

- From the idle mode, press MENU.
- Scroll to MAILBOXES, then press OK.
- Scroll to *either* MAILBOX SETUP line, then press OK.
- Scroll to # OF RINGS: __. (showing the current setting). Press SET.
- Use - or + to adjust the number of rings for that Mailbox, then press SAVE.

Answering System Operation

DAY AND TIME

For accurate time and day stamps on your messages, set the current day and time. Setting either Mailbox will set the other, as well.

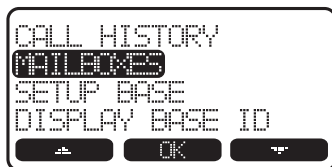

From the Handset or Base Unit:

- From the idle mode, press MENU.
- Scroll to MAILBOXES, then press OK.



- Scroll to *either* MAILBOX SETUP line, then press OK.

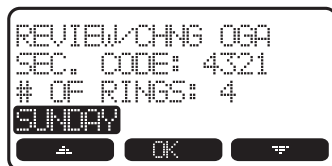

- Scroll to (THE DAY). Press SET.

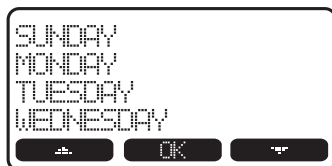

- Scroll to the correct **day**, then press OK.

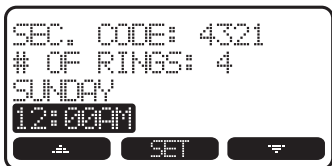

- Scroll to (THE TIME). Press SET.



- The screen says **SETTING TIME**. Use the dial pad to enter the correct hour and minute. If the hour is a single digit, enter it with a preceding **0**. For example: **4** would be entered as **04**. For **AM**, use the ABC (2) key; for **PM**, use the PQRS (7) key.

- Press **SAVE** to confirm the setting.

Answering System Operation

AUDIBLE ALERT

If you want the Base Unit to beep every 10 seconds, alerting you to new messages, set AUDIBLE ALERT to ON. Setting either Mailbox will set the other, as well. This feature is factory preset to OFF.

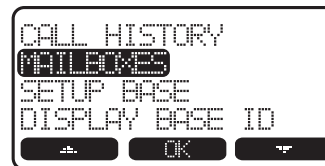

From the Handset or Base Unit:

- From the idle mode, press MENU.

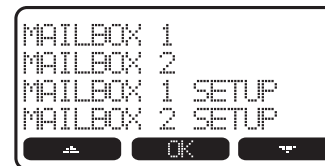

- Scroll to MAILBOXES, then press OK.

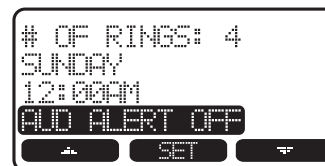

- Scroll to *either* MAILBOX SETUP line, then press OK.

- Scroll to AUD ALERT OFF (or ON), then press SET.



- Select ON or OFF, then press OK to confirm.

Great job!! You are now ready to record your outgoing greetings

RECORDING OUTGOING GREETINGS (ANNOUNCEMENTS)

Your **VT20-2481** Answering System is set at the factory to record messages from your callers (ANSWER + RECORD mode). However, if you do not want callers to leave messages (for example: after business hours), you can program one or both Mailboxes to play your outgoing greeting and then hang up. This is known as ANSWER ONLY mode.

NOTE: For each Mailbox, you can record an ANSWER + RECORD and ANSWER ONLY outgoing greeting. Your **VT20-2481** Answering System will remember all 4 greetings - 2 for each Mailbox!

If you do not record personal greetings, your **VT20-2481** will play its own outgoing greetings. We recommend you record your own greetings, with a recognizable voice and customized announcement.

Answering System Operation

YOU CAN RECORD YOUR OUTGOING GREETINGS FROM EITHER THE VT20-2481 HANDSET OR BASE!!



- From the idle mode, press **MENU**.



- Scroll to **either MAILBOX SETUP** line, then press **OK**.

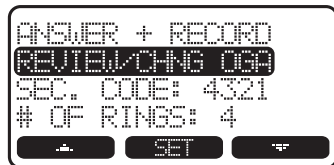

- Scroll to **REVIEW/CHNG OGA**, then, press **SET**.



- Scroll to **RECORD NEW OGA**, then press **OK**.



- After a beep, record your greeting. Speak in a normal tone of voice at the Base Unit or into the Handset, depending on which component you're using to record. Press **STOP** when finished. You will immediately hear your recorded greeting.

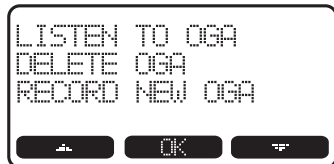

- At this point, your screen options are as shown.

You can re-record your greeting as often as you want. When done, press **CLEAR** (on the Base) or **OFF** (on the Handset) until the screen returns to the *idle* display.

NOTE: Your greeting can be up to 90 seconds.

Answering System Operation

PLAYING AND DELETING MESSAGES

NOTES: All messages are saved until you delete them. Incoming messages can be up to 4 minutes in length.

To play your messages at the Base Unit

When there are new messages in a mailbox, the red light on that Mailbox key will flash. The LCD will display:



If the light is on steady, there are previously played messages that have not been erased.

Press the desired **MAILBOX** key to hear your messages that came in on that particular Line. Use the Volume **Up/Down** keys to adjust the playback to a comfortable level. The Base screen will display the **Caller ID** data for that call.

Press **REPEAT** (↺) to return to the beginning of the message you're listening to. Press **SKIP** (▶) to skip to the next message.

Press **ERASE** during message playback to erase the current message.

When the Base Unit is idle mode, press **ERASE** to erase **all** messages in a mailbox. You will then be prompted to choose either **MAILBOX 1** or **MAILBOX 2**. Press the appropriate **MAILBOX** key to confirm deletion of all messages in that mailbox.

Playback of Messages from the Handset

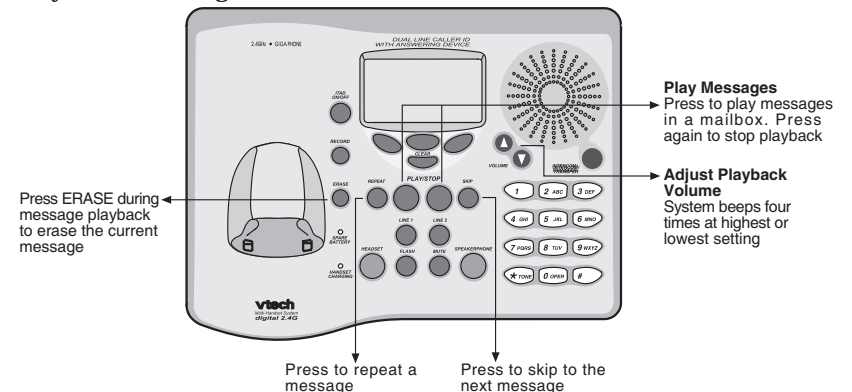

Answering System Operation

- From the idle mode, press **MENU**.



- Scroll to **MAILBOXES**, then press **OK**.



- Scroll to *either* **MAILBOX** line. **Caution:** Do **not** scroll down to **MAILBOX 1 or 2 SETUP!!**

- Press **OK**. You will hear messages from the Handset Speakerphone. In addition, the Handset screen will display the **Caller ID** information for that call.



- Press **BACK** to return to the beginning of the current message.

- Press **ERASE** to delete the current message.

- Press the **VOLUME** key to adjust playback loudness.

- Press **5** to pause; press **1** or **5** to return to playback.

- Press **6** to skip to the next message.

- The Handset display will alert you when all messages in the selected mailbox have been played.



RECORDING A TELEPHONE CONVERSATION

Express Playback of Messages (from Handset or Base Unit)

When you have new, unplayed messages in either Mailbox, press **MENU**.



PLAY NEW MSG will be highlighted on the display. Press **OK** to hear your new messages. When playback is complete, press **OK** to return to the main (idle) menu.

NOTE: In express playback mode, you will **not** be able to erase a message while it is playing.

Answering System Operation

Memo Recording at the Base Unit

Press **RECORD**. The Base will display:



Press the desired Mailbox (**M1** or **M2**). Press **STOP** when finished. Your memo will be stored just like any other incoming message, and can be up to 4 minutes.

From the Base Unit, you can record up to 4 minutes of a phone conversation. While on a Base Speakerphone or Base Headset call:

Press **RECORD** to begin recording.

Press **RECORD** again to end your recording. The recording will also stop when you end your call, or once the recording exceeds 4 minutes.

REMOTE OPERATION OF YOUR VT20-2481 ANSWERING SYSTEM

You can access your Answering System remotely from a touch-tone phone to hear and delete messages, re-record your outgoing greeting, or switch between **ANSWER + RECORD** and **ANSWER ONLY** modes.

From a remote touch-tone phone:

Dial either the **Line 1** or **Line 2** phone number linked to your **VT20-2481**.

While you hear the outgoing greeting, enter #, followed by your **4-digit security code** (you remember it, don't you??).

You will be told if there are any **new** messages. If there are any new messages, after a pause, they will be played for you. A friendly prompt will assist you with the remote commands listed below:

REMOTE OPERATION COMMANDS

PRESS	OPERATION
0 then 1 or 2	Turns each Mailbox ON, OFF
1 then 1 or 2	Play all messages in a Mailbox
2 then 1 or 2	Play all new messages in a Mailbox
3	Delete the current message
3 then 1 or 2	Delete all messages in a Mailbox (in idle mode)
4	Repeat the current message
4, 4	Repeat the previous message
5	Help Menu (in idle mode); STOP Record (in Active mode)
6	Skip to next message
7 then 1 or 2	Review Outgoing Announcement
8 then 1 or 2	Record Outgoing Announcement
9 then 1 or 2	Toggle between Answer + Record and Answer Only modes
*0	Disconnect from Remote Operations
#	Access to prompt for help menu (in idle mode); STOP Play/Record (in Active mode)

Headset Operation

Your **GIGAPHONE** Handset is equipped with a 2.5mm Headset Jack for use with an optional accessory Headset for hands-free operation. If you choose to use the Headset option, you must obtain an optional accessory Headset, which is compatible with the **GIGAPHONE**.

To purchase a Headset, call **VTECH Customer Service at 1-800-595-9511**.

Once you have a compatible 2.5mm Headset, locate the Headset Jack on the **GIGAPHONE** Handset. Connect the plug on the Headset cord to the jack on the cordless Handset. The plug should fit securely. Do not force the connection.



Headset Operation connected to the Handset Unit

NOTE :

Whenever a compatible Headset is connected to the cordless Handset, the microphone on the Handset will be muted. This is done to limit the effect of background noise.

Many compatible Headsets have a reversible, monaural design. You can wear your Headset on either ear, leaving one ear free for room conversation.

Headset Operation connected to the Base Unit

The same type of Headset can be connected to the Base Unit. Facing the Base, the Headset jack can be found on the near corner of the right side panel. When using a Headset attached to the Base, calls are made and answered by pressing the **HEADSET** key. This key is also used to end your call. The Base Speakerphone and Base Headset cannot be used simultaneously. However, you can switch between the two modes without disconnecting your Headset.

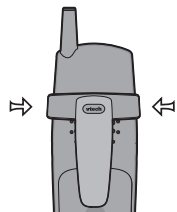
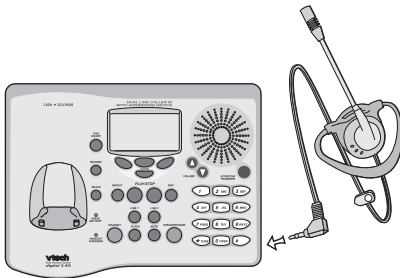

Belt Clip

The **GIGAPHONE** is also equipped with a detachable belt clip. Align the pins on the inside edge of the clip with the notches on the sides of the **GIGAPHONE** Handset. The belt clip should snap securely into place. Do not force the connection.

Maintenance

Taking Care Of Your Telephone

Your **GIGAPHONE** cordless telephone contains sophisticated electronic parts, so it must be treated with care.

Avoid rough treatment

Place the Handset down gently. Save the original packing materials to protect your telephone if you ever need to ship it.

Avoid water

Your telephone can be damaged if it gets wet. Do not use the Handset outdoors in the rain, or handle it with wet hands. Do not install your Base Unit near a sink, bathtub or shower.

Electrical storms

Electrical storms can sometimes cause power surges harmful to electronic equipment.

For your own safety, use caution when using electric appliances during storms.

Cleaning your telephone

Your telephone has a durable plastic casing that should retain its luster for many years. Clean it only with a soft cloth slightly dampened with water or a mild soap. Do not use excess water or cleaning solvents of any kind.

Remember that electrical appliances can cause serious injury if used when you are wet or standing in water. If your Base Unit should fall into water, **DO NOT RETRIEVE IT UNTIL YOU UNPLUG THE POWER CORD AND TELEPHONE LINE CORDS FROM THE WALL.** Then pull the unit out by the unplugged cords.

In Case Of Difficulty

If you have difficulty operating your phone, the suggestions below should solve the problem. If you still have difficulty after trying these suggestions, call VTECH Communications at 1-800-595-9511. In Canada, call VTECH Electronics at 1-800-267-7377.

The Phone Doesn't Work At All

- Make sure the Power Cord is plugged in.
- Make sure the telephone line cord is plugged firmly into the Base Unit and the telephone wall jack.
- Make sure the batteries are properly charged. If the 'LOW BATTERY' message is shown, the battery pack needs charging.
- Is the Handset registered to the Base? See **Registration and Operation**.

No Dial Tone

- First check all the suggestions above.
- If you still don't hear a dial tone, disconnect the Base Unit from the telephone jack and connect a different phone. If there is no dial tone on that phone either, the problem is in your wiring or local service. Contact your local telephone company.

You Get Noise, Static, Or A Weak Signal Even When You're Near The Base Unit

- Household appliances plugged into the same circuit as the Base Unit can sometimes cause interference. Try moving the appliance or the Base Unit to another outlet.

You Get Noise, Static, Or A Weak Signal When You're Away From The Base Unit

- You may be out of range. Either move closer to the Base, or relocate the Base Unit.
- The layout of your home may be limiting the range. Try moving the Base Unit to another position.

The Handset Does Not Ring When You Receive A Call

- Make sure you have the Handset ringer activated. To set the ringer, see **HANDSET and BASE SETTINGS**.
- Make sure the telephone line cord is plugged firmly into the Base Unit and the telephone jack. Make sure the power cord is plugged in.
- You may be too far from the Base Unit.
- You may have too many extension phones on your telephone line to allow all of them to ring. Try unplugging some of the other phones.

In Case Of Difficulty

You Hear Other Calls While Using Your Phone

- Disconnect your Base Unit from the telephone jack, and plug in a regular telephone. If you still hear other calls, the problem is probably in your wiring or local service. Call your local telephone company.

You Hear Noise In The Handset, And None Of The Keys Or Buttons Work

- Make sure the power cord is plugged in.

Common Cure For Electronic Equipment

If the unit does not seem to be responding normally, then try putting the Handset in the cradle. If it does not seem to respond, do the following (in the order listed) :

1. Disconnect the power to the Base.
2. Remove the Handset battery(s) and spare battery pack from the Base, if applicable.
3. Wait a few minutes.
4. Connect power to the Base.
5. Re-install the battery pack (s)
6. Watch for Handset to display :



then

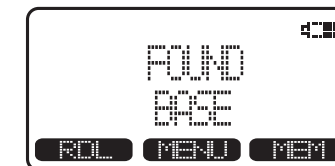

The Answering System Is Not Taking Messages

- Make sure the Answering System is turned *ON*. See **Answering System Operation - Turning Your Answering System ON/OFF** for details.
- Each Mailbox can be set independently to either record your callers' messages or simply play your announcement without taking messages (*Answer Only* mode). See **Answering System Operation - ANSWER + RECORD** for details.

Warranty Statement

What does this limited warranty cover?

- The manufacturer of this VTECH product, VTECH Communications, warrants to the holder of a valid proof of purchase ("Consumer" or "you") that the product and all accessories provided by VTECH in the sales package ("Product") are free from material defects in material and workmanship, pursuant to the following terms and conditions, when installed and used normally and in accordance with operation instructions. This limited warranty extends only to the Consumer for Products purchased and used in the United States of America.

What will VTECH Communications do if the Product is not free from material defects in materials and workmanship during the limited warranty period ("Materially Defective Product")?

- During the limited warranty period, VTECH's authorized service representative will repair or replace at VTECH's option, without charge, a Materially Defective Product. If we repair this product, we may use new or refurbished replacement parts. If we choose to replace this product, we may replace it with a new or refurbished product of the same or similar design. VTECH will return repaired or replacement products to you in working condition. VTECH will retain defective parts, modules, or equipment. Repair or replacement of Product, at VTECH'S option, is your exclusive remedy. You should expect the repair or replacement to take approximately 30 days.

How long is the limited warranty period ?

- The limited warranty period for the product extends for ONE(1)YEAR from the date of purchase if we repair or replace a Materially Defective Product under the terms of this limited warranty. This limited warranty also applies to repaired or replacement Products for a period of either (a) 90 days from the date the repaired or replacement Product is shipped to you or (b) the time remaining on the original one-year warranty; whichever is longer.

What is not covered by this limited warranty ?

1. Product that has been subjected to misuse, accident, shipping or other physical damage, improper installation, abnormal operation or handling, neglect, inundation, fire, water or other liquid intrusion; or
2. Product that has been damaged due to repair, alteration or modification by anyone other than an authorized service representative of VTECH; or
3. Product to the extent that the problem experienced is caused by signal conditions, network reliability or cable or antenna systems; or
4. Product to the extent that the problem is caused by use with non-VTECH electrical accessories; or
5. Product whose warranty/quality stickers, Product serial numbers plates or

Warranty Statement

- electronic serial numbers have been removed, altered or rendered illegible; or
- 6. Product purchased, used, serviced, or shipped for repair from outside the United States, or used for commercial or institutional purposes (including but not limited to Products used for rental purposes); or
- 7. Product returned without valid proof of purchase (see 2 below); or
- 8. Charges for installation or set up, adjustment of customer controls, and installation or repair of systems outside the unit.

How do you get warranty service?

- To obtain warranty service in the United States of America, call 1 800-595-9511 for instructions regarding where to return the Product. Before calling for service, please check the user's manual. A check of the Product controls and features may save you a service call.
- Except as provided by applicable law, you assume the risk of loss or damage during transit and transportation and are responsible for delivery or handling charges incurred in the transport of Product(s) to the service location . VTECH will return repaired or replaced product under this limited warranty to you, transportation, delivery or handling charges prepaid. VTECH assumes no risk for damage or loss of the Product in transit.
- If the Product failure is not covered by this limited warranty, or proof of purchase does not meet the terms of this limited warranty, VTECH will notify you and will request that you authorize the cost of repair prior to any further repair activity. You must pay for the cost of repair and return shipping costs for the repair of Products that are not covered by this limited warranty.

What must you return with the Product to get warranty service?

1. Return the entire original package and contents including the Product to the VTECH service location along with a description of the malfunction or difficulty;
2. Include "valid proof of purchase" (sales receipt) identifying the Product purchased (Product model) and the date of purchase or receipt; and
3. Provide your name, complete and correct mailing address, and telephone number.

Other Limitations

- This warranty is the complete and exclusive agreement between you and VTECH. It supersedes all other written or oral communications related to this Product. VTECH provides no other warranties for this product. The warranty exclusively describes all of VTECH's responsibilities regarding the

Warranty Statement

product. There are no other express warranties. No one is authorized to make modifications to this limited warranty and you should not rely on any such modification.

State Law Rights: This warranty gives you specific legal rights, and you may also have other rights which vary from state to state.

Limitations: Implied warranties, including those of fitness for a particular purpose and merchantability (an unwritten warranty that the product is fit for ordinary use) are limited to one year from date of purchase. Some states do not allow limitations on how long an implied warranty lasts, so the above limitation may not apply to you.

- In no event shall VTECH be liable for any indirect, special, incidental, consequential, or similar damages (including, but not limited to lost profits or revenue, inability to use the product, or other associated equipment, the cost of substitute equipment, and claims by third parties) resulting from the use of this product. Some states do not allow the exclusion or limitation of incidental or consequential damages, so the above limitation or exclusion may not apply to you.

The RBRC® Seal



The RBRC® Seal on the nickel-cadmium battery indicates that VTech Communications, Inc. is voluntarily participating in an industry program to collect and recycle these batteries at the end of their useful lives, when taken out of service within the United States and Canada.

The RBRC® program provides a convenient alternative to placing used nickel-cadmium batteries into the trash or municipal waste, which may be illegal in your area.

VTech's partnership with RBRC® makes it easy for you to drop off the spent battery at local retailers participating in the RBRC® program or at authorized VTech product service centers. Please call **1-800-8-BATTERY™** for information on Ni-Cd battery recycling and disposal bans/restrictions in your area. VTech's involvement in this program is part of its commitment to protecting our environment and conserving natural resources.

RBRC® is a registered trademark of Rechargeable Battery Recycling Corporation.

FCC and IC Regulations

This equipment complies with Parts 15 of the Federal Communications Commission (FCC) rules for the United States. It also complies with regulations RSS210 and CS-03 of Industry and Science Canada. Operation is subject to the following two conditions: (1) this device may not cause interference, and (2) this device must accept any interference, including interference that may cause undesired operation of the device.

A label is located on the underside of the Base Unit containing either the FCC registration number and Ringer Equivalence Number (REN) or the IC registration number and Load Number. You must, upon request, provide this information to your local telephone company.

This equipment is compatible with inductively coupled hearing aids. Should you experience trouble with this telephone equipment, please contact:

VTech Communications Inc.

CUSTOMER SERVICE at 1-800-595-9511. In Canada, call VTECH Electronics at 1-800-267-7377.

For repair/warranty information. The telephone company may ask you to disconnect this equipment from the line network until the problem has been corrected.

FCC Part 15

Warning: Changes or modifications to this unit not expressly approved by the party responsible for compliance could void the user's authority to operate the equipment.

The equipment has been tested and found to comply with part 15 of the FCC rules. These limits are designed to provide reasonable protection against harmful interference in a residential installation. This equipment generates, uses and can radiate radio frequency energy and, if not installed and used in accordance with the instructions, may cause harmful interference to radio communications. However, there is no guarantee that interference will not occur in a particular installation. If this equipment does cause harmful interference to radio or television reception, which can be determined by turning the equipment off and on, the user is encouraged to try and correct the interference by one or more of the following measures:

- Reorient or relocate the receiving antenna.
- Increase the separation between the equipment and receiver.
- Connect the equipment into an outlet or on a circuit different from that to which the receiver is connected.
- Consult the dealer or an experienced radio/TV technician for help.

FCC and ACTA Information

If this equipment was approved for connection to the telephone network prior to July 23, 2001, it was registered with the Federal Commissions (FCC) in accordance with Part 68 of its rules. If the equipment was approved after that date, it complies with the Part 68 rules and with Technical Requirements for Connection of Equipment to the Telephone Network adopted by the

FCC and IC Regulations

Administrative Council for Terminal Attachments (ACTA). We are required to provide you with the following information.

1. Connection and use with the nationwide telephone network

The plug and jack used to connect this equipment to the premises wiring and the telephone network must comply with the applicable Part 68 rules and technical requirements adopted by ACTA. A compliant telephone cord and modular plug is provided with this product. It is designed to be connected to a compatible modular jack that is also compliant. An RJ11 jack should normally be used for connecting to a single line and an RJ14 jack for two lines. See Installation Instructions in the user's manual. This equipment may not be used with Coin Telephone Lines or with Party Lines.

2. Product identifier and REN information

The label on the back or bottom of this equipment contains, among other things, an identifier indicating product approval and the Ringer Equivalence Number (REN). This information must be provided to your local telephone company upon request. For equipment approved prior to July 23, 2001, the product identifier is preceded by the phrase "FCC Reg No." and the REN is listed separately. For equipment approved after that date, the product identifier is preceded by "US" and a colon (:), and the REN is encoded in the product identifier as the sixth and seventh characters following the colon. For example, the product identifier US: AAAEQ03T123XYZ would indicate an REN of 0.3.

The REN is used to determine how many devices you may connect to your telephone line and still have them ring when you are called. In most, but not all areas, the sum of all RENS should be five (5.0) or less. You may want to connect your local telephone company for more information.

3. Repair instructions

If the equipment is malfunctioning, it must be unplugged from the modular jack until the problem has been corrected. Repairs to this telephone equipment can only be made by the manufacturer or its authorized agents. For repair procedures, follow the instructions outlined under the Limited Warranty.

4. Rights of the telephone company

If this equipment is causing harm to the telephone network, the telephone company may temporarily discontinue your telephone service. The telephone company is required to notify you before interrupting service. If advance notice is not practical, you will be notified as soon as possible. You will be given the opportunity to correct the problem and the telephone company is required to inform you of your right to file a complaint with the FCC. Your telephone company may make changes in facilities, equipment, operation, or procedures that could affect the proper functioning of this product. The telephone company is required to notify you if such changes are planned.

5. Hearing aid compatibility

If this product is equipped with a corded or cordless handset, it is hearing aid compatible.

6. Programming/testing of emergency numbers

If this product has memory dialing locations, you may choose to store police, fire department and emergency medical service telephone number in this locations. If you do, please keep three things in mind:

FCC and IC Regulations

- a. We recommend that you also write the telephone number on the directory card, so that you can still dial the emergency number manually if the memory dialing feature doesn't work.
- b. This feature is provided only as a convenience, and the manufacturer assumes no responsibility for customer reliance upon the memory feature.
- c. Testing the emergency telephone numbers you have stored is not recommended. However, if you do make a call to an emergency number:
 - You must remain on the line and briefly explain the reason for the call before hanging up.
 - Programming/testing of emergency numbers should be performed during off-peak hours, such as in the early morning or late evening, when the emergency services tend to be less busy.

IC (Industry Canada)

This telephone is registered for use in Canada.

Notice :

The REN assigned to this device denotes the number of devices you may connect to the telephone loop which is used by the device to prevent overloading. The termination on a loop may consist of any combination of devices subjected only to the requirement that the sum of the REN does not exceed five (5.0)

Notice :

The Industry Canada label identifies certified equipment. This certification means that the equipment meets certain telecommunications network protective, operational and safety requirements. The Department does not guarantee the equipment will operate to the user's satisfaction.

Before installing this equipment, users should ensure that it is permissible to be connected to the facilities of the local telecommunications company. The equipment must also be installed using an acceptable method of connection. The customer should be aware that compliance with the above conditions may not prevent degradation of services in some situations.

Repairs to certified equipment should be made by an authorized Canadian maintenance facility designated by the supplier. Any repairs or alterations made by the user to this equipment, or equipment malfunctions, may give the telecommunications company cause to request the user to disconnect the equipment.

Users should ensure for their own protection that the electrical ground connections of the power utility, telephone lines and internal metallic water pipe system, if present, are connected together. This precaution may be particularly important in rural areas.

Caution :

Users should not attempt to make such connections themselves, but should contact the appropriate electrical inspection authority, or electrician, as appropriate.

Your Gigaphone is designed to operate at the maximum power allowed by the FCC and IC. This means your Handset and Base Unit can communicate only over a certain distance - which will depend on the location of the Base Unit and Handset, weather, and the construction and layout of your home or office.

Technical Specifications

FREQUENCY CONTROL

Crystal controlled
PLL synthesizer

TRANSMIT FREQUENCY

2401.056 - 2481.408 MHz

RECEIVE FREQUENCY

2401.056 - 2481.408 MHz

CHANNELS

94 Channels

NOMINAL EFFECTIVE RANGE

Maximum power allowed by FCC and IC. Actual operating range may vary according to environmental conditions at the time of use.

SIZE

Handset : 50mm x 34mm x 174mm

Base : 206mm x 146mm x 70mm

WEIGHT

Handset : 116 grams
Base : 587 grams

POWER REQUIREMENTS

Handset: 2.4V 1500mAh NiMH or
2.4V 800mAh Ni-Cd
Battery Pack

Base : 7 VDC @ 900mA

MEMORY

Speed Dial: 50 Memory locations
32 digits per location

CID : Alpha Numeric Display
50 Memory locations

**SPECIFICATIONS ARE TYPICAL
AND MAY CHANGE WITHOUT
NOTICE.**

Table Of Contents

1. Important Safety Instructions	28.	Mute Function
	28.	Hold Function
	28.	Flash Function
	29.	How to adjust the Handset Volume
	29.	Base Speakerphone or Headset Volume
	29.	Intercom Function
	30.	Transferring Calls
	30.	Handsfree Speakerphone Operation
	31.	Switching from the Handset Earpiece to Handsfree
	31.	Base Speakerphone Operation
	31.	Line in Use Indication
	31.	Low Battery Indication
	32.	Conference Calling
	32.	2-Line Conference Calls
	33.	Answering System Operation
	33.	Turning Your Answering System On/Off
	34.	Answering System Setup
	35.	Answer + Record
	36.	Security Code
	37.	Number of Rings
	38.	Day and Time
	39.	Audible Alert
	39.	Recording Outgoing Greetings (Announcements)
	41.	Playing and Deleting Messages
	43.	Memo Recording at the Base Unit
	43.	Recording a Telephone Conversation
	43.	Remote Operation
3. Introduction		
4. Parts Check List		
5. The Handset Layout		
6. The Base Unit Layout		
7. Getting Started		
7. Setup		
8. Installation of Battery Pack in Handset		
9. Charging Of Handset Battery Pack		
10. Dial Tone		
11. Spare Battery Charger/Power Backup Function		
12. Registration and Operation		
14. Basic Operation		
14. Handset and Base Indicators		
16. Soft Menu Functions		
16. RDL (Redial)		
16. Handset Menu		
16. Base Unit Menu		
17. Call History (Caller ID)		
19. Handset and Base Settings		
19. Ringers		
20. Low Batt Tone		
20. Range Tone		
20. Keypad Tone		
20. Contrast		
20. Select Tone/Pulse at the Base Unit		
21. Enhanced Mode		
21. Rename		
22. Register and Memory		
23. Memory		
23. To Store a Number/Name		
24. To Search For and Dial a Number/Name		
24. To Delete a Number/Name		
25. To Edit a Number/Name		
26. Advanced Operations		
26. Handset and Base Operation		
26. Making Calls		
27. Redial		
27. Answering Calls		
	28.	Mute Function
	28.	Hold Function
	28.	Flash Function
	29.	How to adjust the Handset Volume
	29.	Base Speakerphone or Headset Volume
	29.	Intercom Function
	30.	Transferring Calls
	30.	Handsfree Speakerphone Operation
	31.	Switching from the Handset Earpiece to Handsfree
	31.	Base Speakerphone Operation
	31.	Line in Use Indication
	31.	Low Battery Indication
	32.	Conference Calling
	32.	2-Line Conference Calls
	33.	Answering System Operation
	33.	Turning Your Answering System On/Off
	34.	Answering System Setup
	35.	Answer + Record
	36.	Security Code
	37.	Number of Rings
	38.	Day and Time
	39.	Audible Alert
	39.	Recording Outgoing Greetings (Announcements)
	41.	Playing and Deleting Messages
	43.	Memo Recording at the Base Unit
	43.	Recording a Telephone Conversation
	43.	Remote Operation
	44. Additional Information	
	44.	Headset Operation
	45.	Maintenance
	46.	In Case Of Difficulty
	48.	Warranty Statement
	50.	The RBRC Seal
	51.	FCC and IC Regulations
	54.	Technical Specifications

vtech

VTECH TELECOMMUNICATIONS LTD.
A member of THE VTECH GROUP OF COMPANIES.

Distributed in the U.S.A. by VTech Communications Inc.; Beaverton, Oregon.

Distributed in Canada by VTech Electronics Canada Ltd., Suite 200, 7671 Alderbridge
Way, Richmond, B.C. V6X 1Z9.

Copyright 2002 for VTECH TELECOMMUNICATIONS LTD.
Printed in China

91-5262-10-00
ISSUE 0